

# Operation Manual

## PA-935A Amplifier

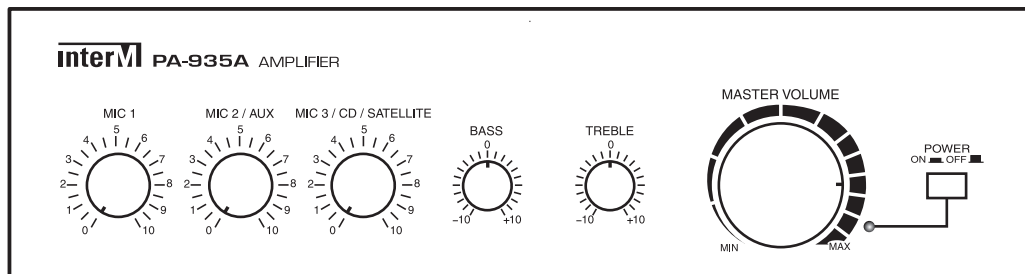

**interM**

# Contents

|                                     |    |
|-------------------------------------|----|
| <b>Welcome</b>                      |    |
| Warning.....                        | 1  |
| Unpacking.....                      | 2  |
| <b>Installation</b>                 |    |
| Environment.....                    | 2  |
| Important Safety Instructions.....  | 2  |
| <b>Features</b> .....               | 3  |
| Accessories.....                    | 3  |
| <b>Front Panel</b> .....            | 4  |
| <b>Rear Panel</b> .....             | 5  |
| <b>Connecting Speakers</b> .....    | 7  |
| <b>Applications</b> .....           | 8  |
| <b>Block Diagram</b> .....          | 9  |
| <b>Specifications</b> .....         | 10 |
| <b>Service</b>                      |    |
| Procedures.....                     | 11 |
| Schematic.....                      | 11 |
| Parts List.....                     | 11 |
| <b>Variations and Options</b> ..... | 11 |
| <b>Warranty</b> .....               | 11 |

# Welcome

## A personal welcome to you from the management and employees of Inter-M

All of the co-workers here at Inter-M are dedicated to providing excellent products with inherently good value, and we are delighted you have purchased one of our products.

We sincerely trust this product will provide years of satisfactory service, but if anything is not to your complete satisfaction, we will endeavor to make things right.

Welcome to Inter-M, and thank you for becoming part of our worldwide extended family!

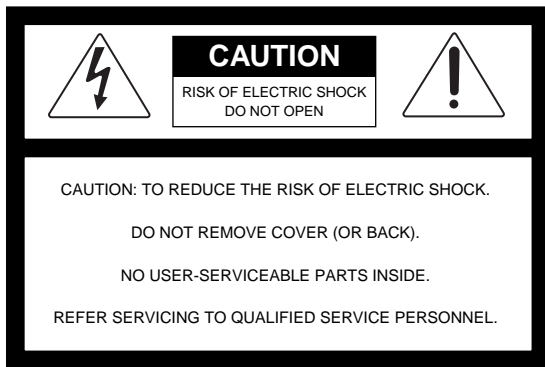

### WARNING

To prevent fire or shock hazard, do not expose the unit to rain or moisture.

\*Do not install this equipment in a confined space such as a book case or similar unit.

\*The apparatus shall not be exposed to dripping or splashing and no objects filled with liquids, such as vases, shall be placed on the apparatus.

\*Worded: "WARNING FOR YOUR PROTECTION PLEASE READ THE FOLLOWING-WATER AND MOISTURE: Unit should not be used near water (e.g. near a bathtub, washbowl, kitchen sink, laundry tub, in a wet basement, or near a swimming pool, etc). Care should be taken so that objects do not fall and liquids are not spilled into the enclosure through openings."



This symbol is intended to alert the user to the presence of uninsulated "dangerous voltage" within the product's enclosure that may be of sufficient magnitude to constitute a risk of electric shock to persons.



This symbol is intended to alert the user to the presence of important operation and maintenance (servicing) instructions in the literature accompanying the appliance.

Caution: To prevent electric shock do not use this (polarized) plug with an extension cord, receptacle or other outlet unless the blades can be fully inserted to prevent blade exposure.

Attentions: Pour prévenir les chocs électriques ne pas utiliser cette fiche polarisée avec un prolongateur, une prise de courant ou une autre sortie de courant, sauf si les lames peuvent être insérées à fond sans en laisser aucune partie à découvert.

## Unpacking

Although your PA-935A is neither complicated nor difficult to operate, we recommend you take a few minutes to read this brief manual and familiarize yourself with the important information regarding product features, setup and operation.

As with most electronic devices, we strongly recommend you retain the original packaging. In the unlikely event the product must be returned for servicing, the original packaging (or reasonable equivalent) is required.

## Installation

### Environment

Never place this product in an environment which could alter its performance or reduce its service life. Such environments usually include high levels of heat, dust, moisture, and vibration.

### Important Safety Instructions

1. Read these instructions.
2. Keep these instructions.
3. Heed all warnings.
4. Follow all instructions.
5. Do not use this apparatus near water.
6. Clean only with dry cloth.
7. Do not block any ventilation openings. Install in accordance with the manufacturer's instructions.
8. Do not install near any heat sources such as radiators, heat registers, stoves, or other apparatus (including amplifiers) that produce heat.
9. Do not defeat the safety purpose of the polarized or grounding-type plug. A polarized plug has two blades with one wider than the other. A grounding type plug has two blades and a third grounding prong. The wide blade or the third prong are provided for your safety. If the provided plug does not fit into your outlet, consult an electrician for replacement of the obsolete outlet.
10. Protect the power cord from being walked on or pinched particularly at plugs, convenience receptacles, and the point where they exit from the apparatus.
11. Only use attachments/accessories specified by the manufacturer.
12. Use only with the cart, stand, tripod, bracket, or table specified by the manufacturer, or sold with the apparatus. When a cart is used, use caution when moving the cart/apparatus combination to avoid injury from tip-over.
13. Unplug this apparatus during lightning storms or when unused for long periods of time.
14. Refer all servicing to qualified service personnel. Servicing is required when the apparatus has been damaged in any way, such as power-supply cord or plug is damaged, liquid has been spilled or objects have fallen into the apparatus, the apparatus has been exposed to rain or moisture, does not operate normally, or has been dropped.



## Features

- **HIGH POWER, LOW DISTORTION**

35W of RMS power, with less than 5% THD.

- **VERSATILE AND CONVENIENT**

Three mixable inputs: Mic 1, Mic2/Aux, Mic3/CD/Satellite.

- **CONFIGURABLE**

Mic2/Aux and Mic3/CD/Satellite are individually selectable.

- **TELEPHONE PAGING INPUT**

Telephone input for connection with telephone system.

- **PRIORITY MUTING**

Mic 2/Aux and Mic3/CD/Satellite inputs mute when telephone paging and/or Mic 1 in use.

- **TONE CONTROL**

Separate Bass and Treble controls to tailor your sound.

### Accessories

One detachable AC power cord is provided for use with this product.

## Front Panel

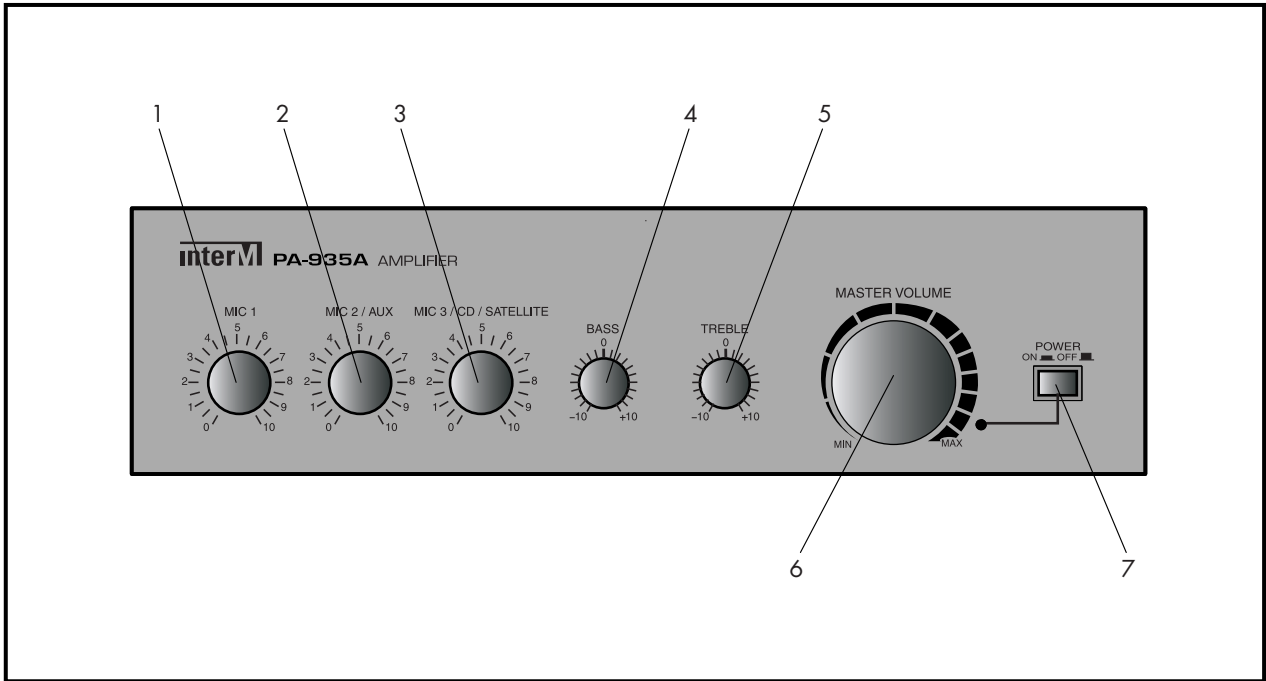

### 1. MIC VOLUME 1

This knob provides continuous control of the volume of Mic 1

### 2. MIC VOLUME 2/AUX

This knob provides continuous control of the volume of Mic 2/AUX

### 3. MIC VOLUME 3/CD/SATELLITE

This knob provides continuous control of the volume of Mic 3/CD/SATELLITE.

### 4. BASS CONTROL

This knob provides continuous control of the low frequency response, by adding up to 10dB of cut (decrease) or boost (increase).

### 5. TREBLE CONTROL

This knob provides continuous control of the high frequency response, by adding up to 10dB of cut (decrease) or boost (increase).

### 6. MASTER VOLUME

This knob provides continuous control of the overall volume of output.

### 7. POWER SWITCH

Pressing this switch turns the unit on. Pressing it again turns the unit off.

## Rear Panel

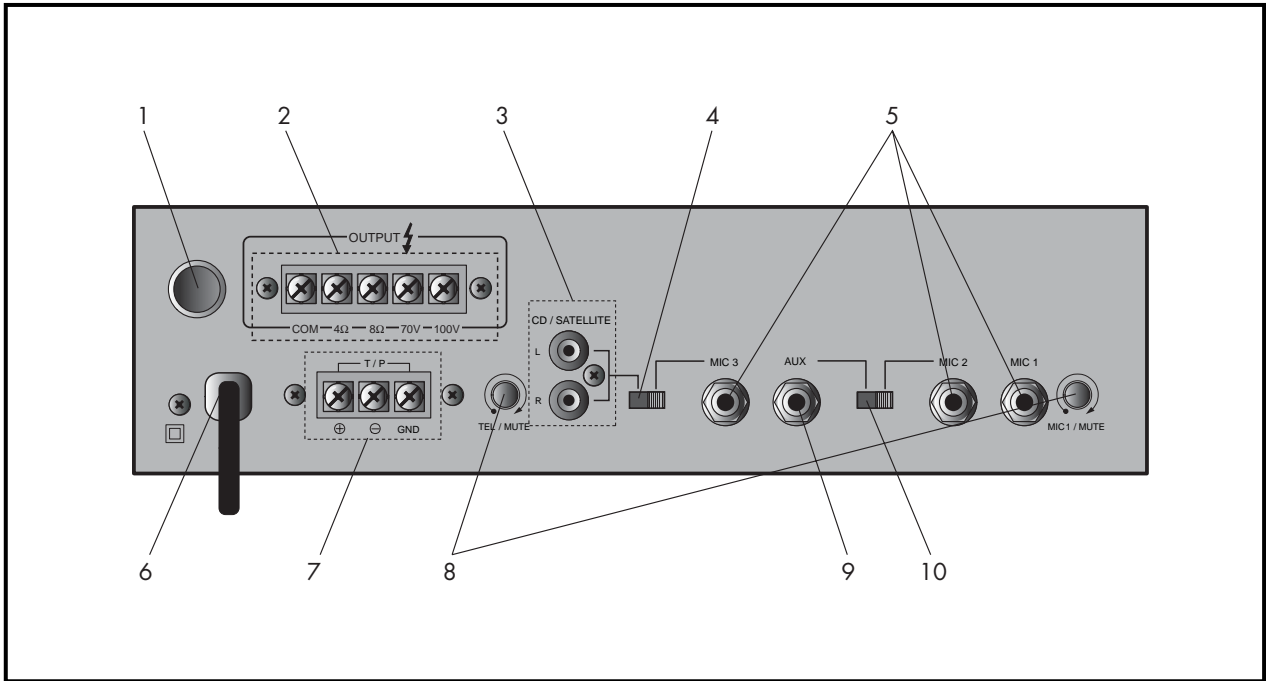

### 1. FUSE HOLDER

This holder contains the AC overload protection fuse. If the fuse has blown out, replace it with a fuse of the same type and rating, as shown below.

If the fuse continues to blow, refer servicing to a qualified service technician.

| AC Fuse Ratings |             |             |
|-----------------|-------------|-------------|
| Model           | 100V-120VAC | 220V-240VAC |
| PA-935A         | 2A/250V     | 1A/250V     |

### 2. SPEAKER OUTPUT TERMINAL

These terminals are used to connect speakers to the unit. You may select either 4Ω or 8Ω conventional operation, or High Impedance operation at either 70V or 100V.

### 3. CD/SATELLITE INPUT

This RCA jack accepts a standard line-level input. Mic input 3 may be set to line-level with the use of its associated Mic3/CD/SATELLITE switches.

### 4. MIC 3/CD/SATELLITE SELECTOR SWITCH

This switch is used to select between mic level and line level for Mic 3/CD/SATELLITE input.

### 5. MIC 1,2,3 INPUTS

These 1/4" phone jacks accept a standard mic-level or line-level input. Mic inputs 2 and 3 may be set to line-level with the use of their associated Mic/Aux switches.

**6. AC CORD**

Connect this cable to your AC outlet.

**7. TELEPHONE IN TERMINAL**

These terminals are used to connect to a telephone exchange system for paging purposes.

NOTE: When signal is present on the Telephone Input terminal, all other input signals (except Mic 1) are muted.

**8. MUTE CONTROLS**

When signal is present at Mic 1 or Telephone input, all other inputs are muted. These controls adjust the level of Mic 1 and Telephone output when muting is in use.

**9. AUX INPUT**

This input is used for connecting line-level sources, such as CD or cassette deck. When using this input, the respective Mic/AUX switch must be set to its AUX setting.

**10. MIC 2/AUX SELECTOR SWITCH**

This switch is used to select between mic level and line level for Mic 2/AUX input.



# Connecting Speakers

Before connecting speakers to your PA-935A unit, be sure to disconnect the AC power cable. Make certain that the total impedance is not less than the rated impedance indicated.

For 4Ω low-impedance speakers, connect in parallel, with the negative (-) connectors to the 4Ω terminal and the positive (+) connectors to the COM terminal. See Figure 2-1 below.

For 8Ω low-impedance speakers, connect in parallel, with the negative (-) connectors to the 8Ω terminal and the positive (+) connectors to the COM terminal. See Figure 2-2 below.

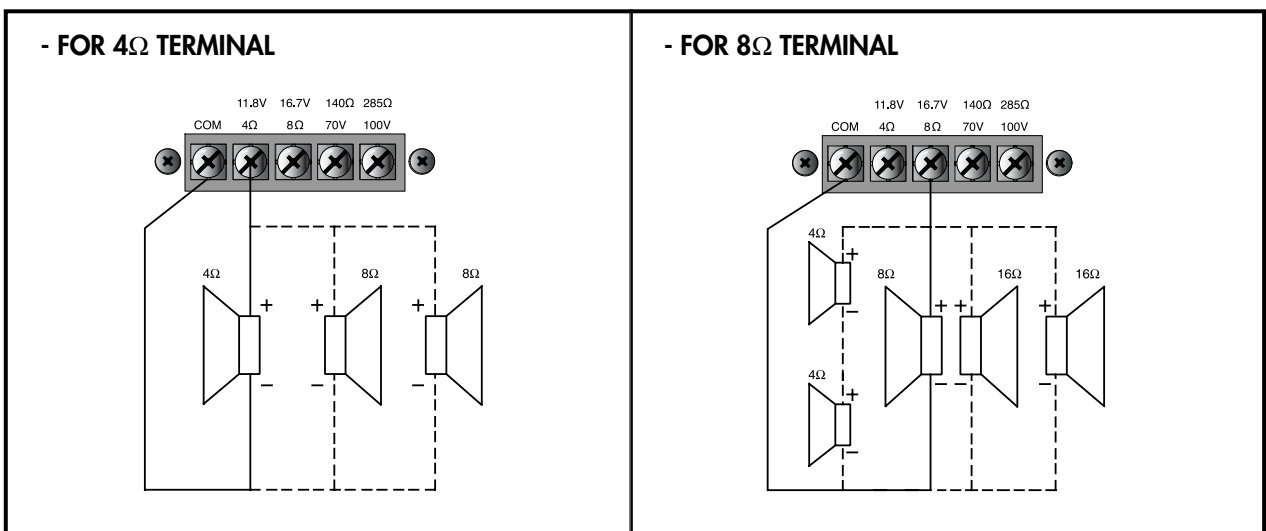

For high-voltage distributed systems, connect with matching transformer as per Figures 2-3 and 2-4 below. Be certain that the total impedance does not equal less than the rated impedance.

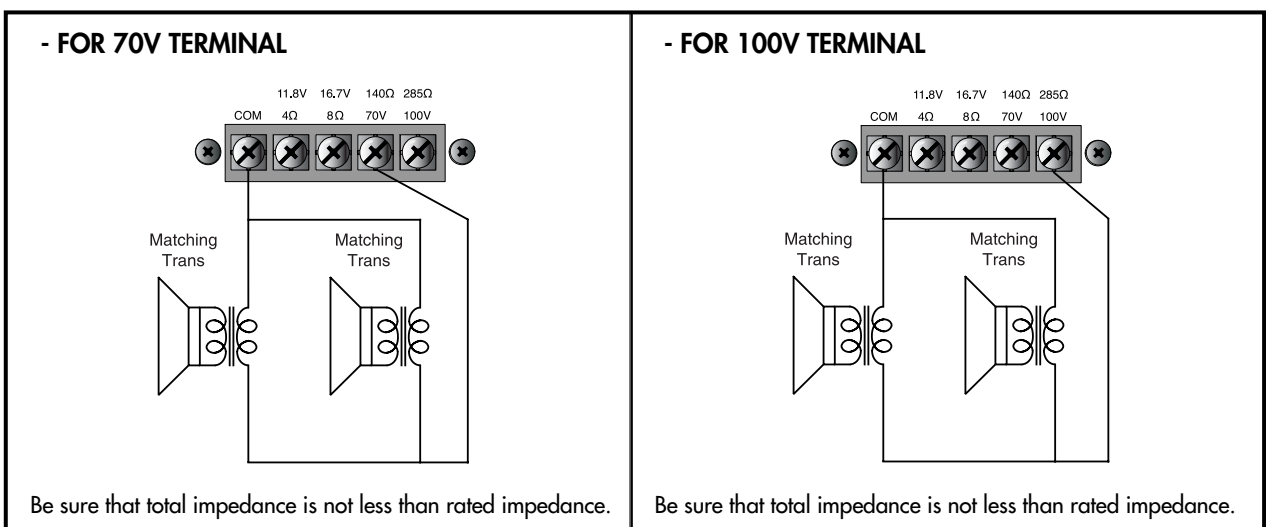

# Applications

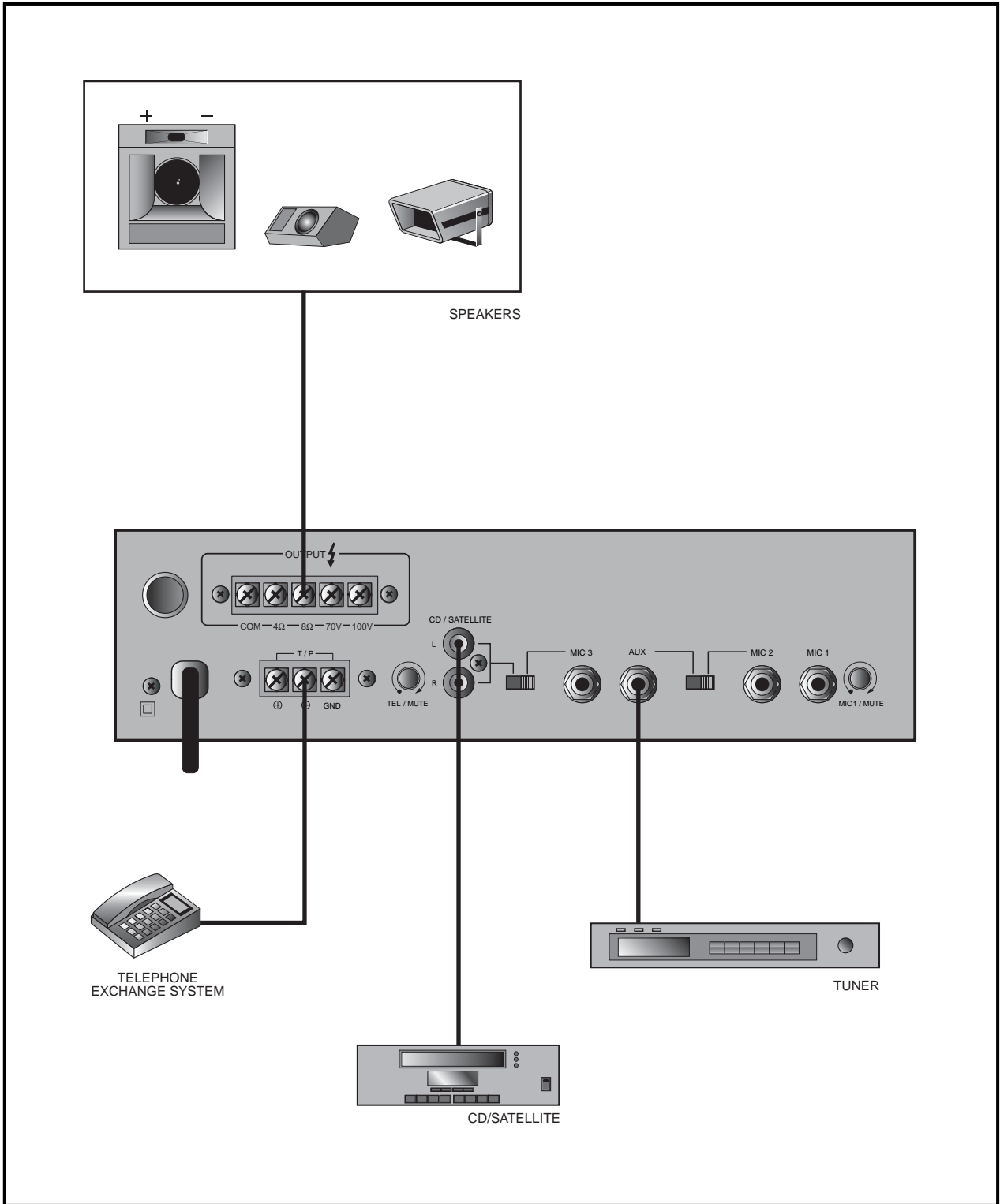

# Block Diagram

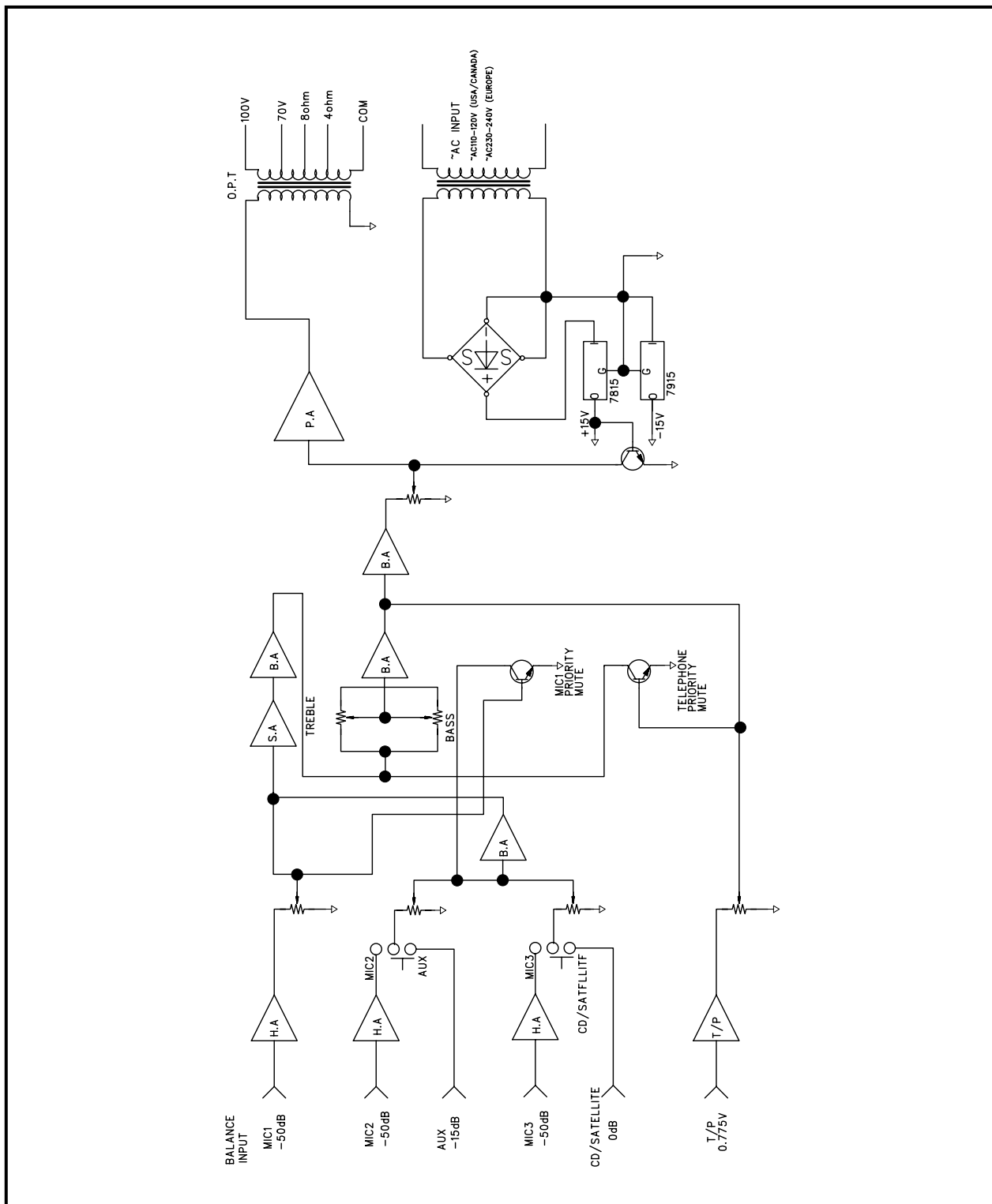

## Specifications

### - ELECTRICAL

|  |   |
|--|---|
| Rated Output Power (at THD: 5%).....                   | 35W(RMS)  |
| Frequency Response( $\pm 3$ dB)                        |   |
| MIC 1, 2, 3.....                                       | 150Hz-12kHz   |
| AUX.....   | 80Hz-15kHz  |
| CD/SATELLITE.....                                      | 80Hz-15kHz  |
| TELEPHONE.....   | 330Hz-3kHz  |
| Total Harmonic Distortion (at Rated Output, 1kHz)..... | Less Than 5%  |
| Signal to Noise Ratio                                  |   |
| MIC 1, 2, 3.....                                       | Better than 55dB  |
| AUX, CD/SATELLITE, TELEPHONE.....                      | Better than 65dB  |
| Input Sensitivity/Impedance                            |   |
| MIC 1, 2, 3.....                                       | -50dB/600 $\Omega$  |
| AUX.....   | -15dB/10k $\Omega$  |
| CD/SATELLITE.....                                      | 0dB/10k $\Omega$  |
| TELEPHONE.....   | 0.775V/600 $\Omega$   |
| Output Voltage/Impedance.....                          | 4 $\Omega$ /11.8V, 8 $\Omega$ /16.7V, 140 $\Omega$ /70V, 285 $\Omega$ /100V |

### - GENERAL

|                        |  |
|------------------------|--|
| Power Source.....      | 100–120VAC or 220–240VAC; 50/60Hz<br>(Supplied AC mains transformer depends on country requirements) |
| Power Consumption..... | 40W  |
| Weight.....            | 4.4kg/9.7lb  |
| Dimensions.....        | 290(W)x76(H)x185(D)mm/11.4(W)x3(H)x7.3(D)in  |

\* Specifications and design subject to change without notice.

## Service

### Procedures

Ensure the problem is not related to operator error, or system devices that are external to this unit. Information provided in the troubleshooting portion of this manual may help with this process. Once it is certain that the problem is related to the product contact your warranty provider as described in the warranty section of this manual.

### Schematic

A Schematic is available by contacting your warranty provider.

### Parts List

A Parts List is available by contacting your warranty provider.

## Variations and Options

### Variations

Products supplied through legitimate sources are compatible with local AC power requirements.

### Options

No optional items are available for this product.

## Warranty

Warranty terms and conditions vary by country and may not be the same for all products. Terms and conditions of warranty for a given product may be determined first by locating the appropriate country which the product was purchased in, then by locating the product type.

To obtain specific warranty information and available service locations contact Inter-M directly (in Korea or the USA) or the authorized Inter-M Distributor for your specific country or region.



Inter-M, Ltd. (Korea) began operations in 1983.

Since then, Inter-M has grown to become one of the largest manufacturers of professional audio and commercial sound electronics equipment in the world.

Inter-M has gained worldwide recognition for its own branded products, as well as private label manufacturing of electronics sold under other names (OEM).

The company is no longer just a Korean company, but rather a global company that is truly international in scope, with factories and offices in Korea and China, and sales and marketing operations located in Japan, Europe, and the U.S.A.

With more than 850 employees around the globe, Inter-M is well-poised for further growth and expansion.

**INTER-M AMERICAS, INC.**

1 EAST BEACON LIGHT LANE CHESTER, PA USA 19013-4409

TEL : 1-610-874-8870, FAX : 1-610-874-8890

Home Page : <http://www.inter-m.net>, E-mail : [service@inter-m.net](mailto:service@inter-m.net)

**INTER-M Corporation**

SEOUL OFFICE: 653-5 BANGHAK-DONG, DOBONG-KU, SEOUL, KOREA

TEL : 82-2-2289-8140~8, FAX : 82-2-2289-8149

Home Page : <http://www.inter-m.com>, E-mail : [export@inter-m.com](mailto:export@inter-m.com)

MADE IN CHINA  
December 2005 9007203200 A